



**INNOVATIVE DISPLAY TECHNOLOGIES**

**17171 Murphy Avenue  
Irvine, California 92614-5915  
P: 949-417-8070/F: 949-417-8075**

E-mail: [info@shellyinc.com](mailto:info@shellyinc.com)  
Website: [www.shellyinc.com](http://www.shellyinc.com)

## **Specification**

**Part Number : SCA04310-BFN-LRA**

**Customer :**

<b>APPROVED BY:</b>  ( FOR CUSTOMER USE ONLY )	<b>PCB VERSION: A401T</b>  <b>DATE:</b>
--	---

SOLD BY	APPROVED BY	CHECKED BY	ISSUE DATE

## **CONTENTS**

<b><i>NO.</i></b>	<b><i>ITEM</i></b>	<b><i>PAGE</i></b>
1.	<b>Cover</b>	1
2.	<b>Record of Reversion</b>	2
3.	<b>LCD Module Physical Data</b>	3
4.	<b>External Dimensions</b>	4
5.	<b>Block Diagram</b>	5~6
6.	<b>Absolute Maximum Ratings</b>	6
7.	<b>Electrical Characteristics</b>	7
8.	<b>Touch Screen Panel Specifications</b>	8
9.	<b>Interface PIN Connections</b>	9
10.	<b>Electro-Optical Characteristics</b>	10~15
11.	<b>Inspection Criterion</b>	16~19
12.	<b>Precautions For Using LCD Modules</b>	20~21
13.		

## 2. RECORD OF REVISION

DATE	PAGE	SUMMARY
9/30/09	1	Version A401T

### ◆ 3. LCD MODULE PHYSICAL DATA

#### ● General Description

Display Type	16.7 M TFT
Display Mode	POSITIVE
Viewing Direction	6 o'clock
Connection Type	COG
Operation temperature	-20°C~70°C
Storage temperature	-30°C~80°C
Driving IC	HX8257

#### ● Mechanical Description

Item	Standard Value	Unit
Number of dots	480RGB×272dots	-
LCM dimension	105.50(W)×67.20(H)×4.05(T)	mm
TP viewing area	97.70(W)×55.90(H)	mm
TP active area	95.44(W)×54.26(H)	mm
Active area	95.04(W)×53.86(H)	mm
Dot size	0.188(W)×0.188(H)	mm
Dot pitch	0.198(W)×0.198(H)	mm
Backlight	12 chip white LEDS	/
The KEY and accessory materials of our product according with BHS-001 standard		



◆ 5. BLOCK DIAGRAM

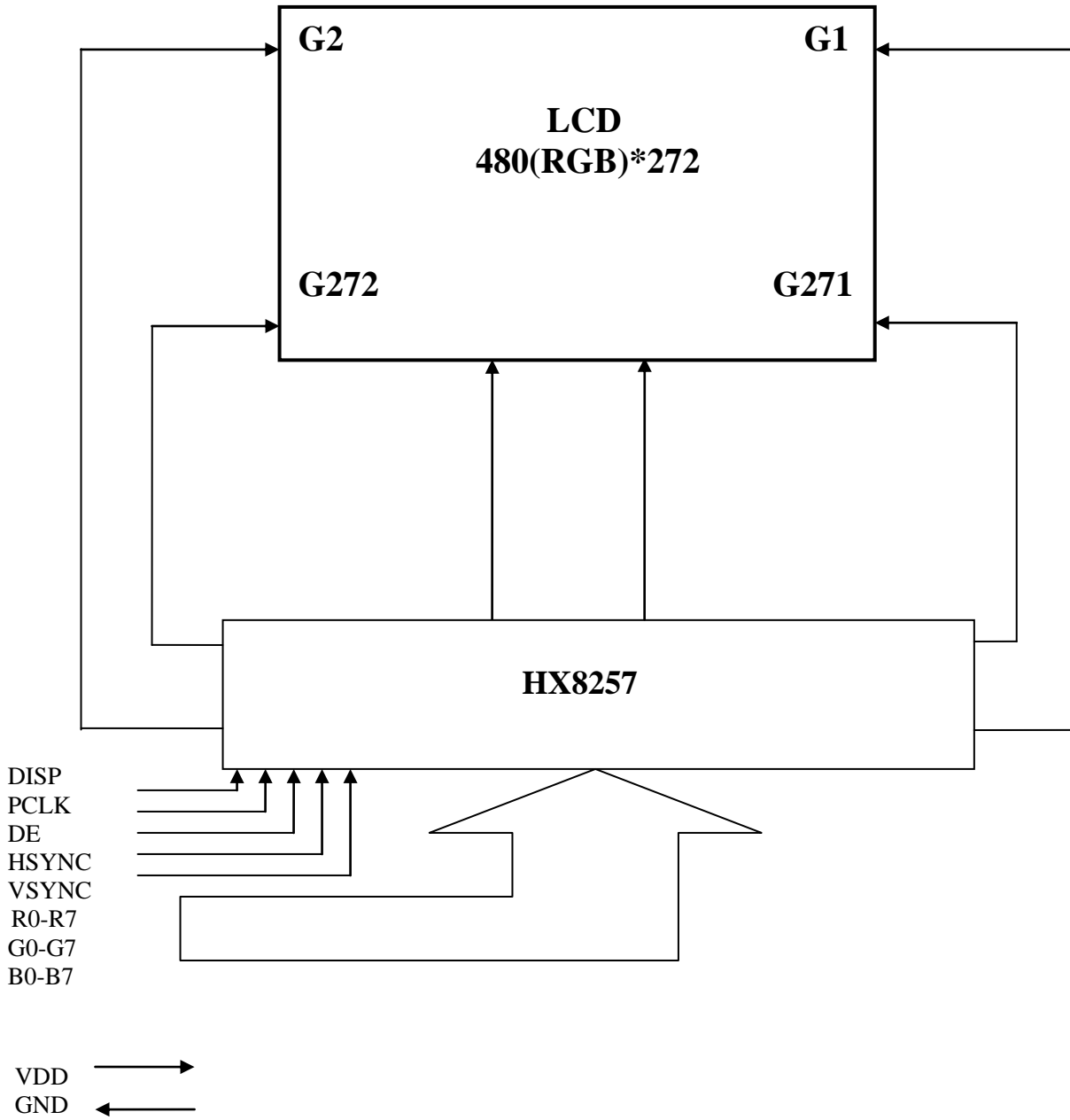

● Black Light Unite

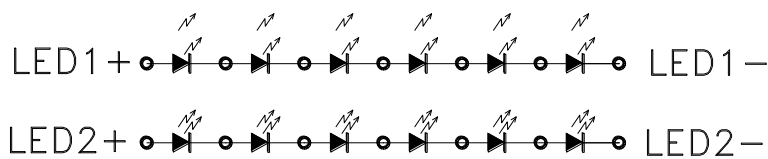

● Touch Screen Panel(Top View)

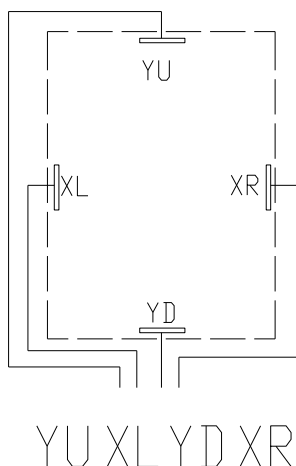

## ◆ 6. ABSOLUTE MAXIMUM RATINGS

Item	Symbol	Rating	Unit
Operating temperature	Top	-20 to 70	°C
Storage temperature	Tst	-30 to 80	°C
Power Supply Voltage	VDD	-0.3 to 4.0	V

### NOTE:

1. If the module is used above these absolute maximum ratings. It may become permanently damaged. Using the module within the following electrical characteristic conditions are also exceeded, the module will malfunction and cause poor reliability.
2. VDD>GND must be maintained.

## ◆ 7. ELECTRICAL CHARACTERISTICS

### ● DC Characteristics

Item	Symbol	Condition	Min	Typ	Max	Unit
Input high voltage	V <sub>IH</sub>	-	0.8 VDD	-	VDD	V
Input low voltage	V <sub>IL</sub>	-	0	-	0.2VDD	V
Supply voltage(1)	V <sub>CI</sub>	Ta=25°C	≥ VDDI 0	3.3	3.6	-
Supply voltage(2)	VDDIO	Ta=25°C	-	-	-	V
			1.8	3.3	3.6	-
Logic dynamic current	IDD1	-	-	-	-	mA
Driver dynamic current	IDD2	-	-	-	-	mA

### ● Back-Light unit

Item	Symbol	Min	Typ	Max	Unit	Remark
Current	I <sub>BL</sub>	-	16	-	mA	-
CIE	X	0.25	-	0.29	-	X>Y
	Y	0.24	-	0.28	-	
Brightness	-	3800	-	4800	cd/m <sup>2</sup>	-
Luminous Uniformity Ratio	-	80	-	-	%	-
Bezel(BE) must be connected to ground of the main board						

Note:

1. Average Luminous Intensity of P1 ~ P5 ( Using a luminance meter BM-7 )
  2. Luminous Intensity Ratio = min/max \* 100%
- Measured Method (X\*Y: Light Area).

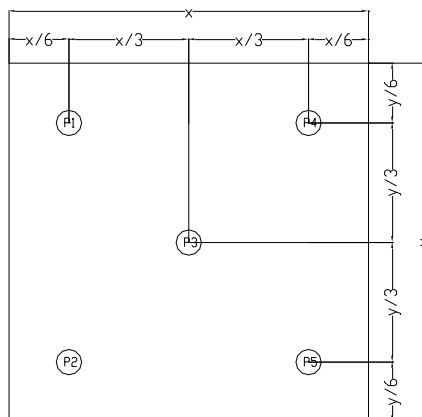

### ● AC Characteristics

Refer to the SPEC of HX8257



## ◆ 8. TOUCH SCREEN PANEL SPECIFICATIONS

### 1. Electrical Characteristics

Item	Min	Typ	Max	Unit	Note
Linearity	-	-	1.5	%	X-Axis, Y-Axis
Terminal Resistance	600	-	1300	Ω	X(Glass side)
	100	-	800	Ω	Y(Film side)
Insulation Resistance	10	-	-	MΩ	DC 25V
Operating voltage	-	-	5	V	DC
Response Time	-	-	10	Ms	-
Transmittance	80	-	-	%	-

Note 1) : Do not operate it with a thing except a polyacetal pen (tip R0.8mm or less) or a finger, especially those with hard or sharp tips such as a ball point pen or a mechanical pencil

### 2. Mechanical & Durability Characteristics

Item	Min	Typ	Max	Unit	Note
Operating Force	50	-	200	G	(1)
Touch Test	1,000,000	-	-	Times	(2)
Handwriting Friction Test	100,000	-	-	Times	(3)
Surface hardness	3	-	-	H	(4)

Note (1) Pen : 0.8N or less (R0.8mm)

Finger : 0.8N or less (0.8mm)

(2) Measurement for Center part of Panel

-Hitting Pad : Tip R8mm Silicon Rubber & Tip R0.8mm Stylus pen

-Lode :150gf

-Speed :2times/sec

-Electric lode :None

(3) Measurement for 2.0mm inside of transparent insulation

-Sliding Pen : Tip R0.8mm Stylus pen

-Lode :150gf

-Speed :60mm/sec

-Sliding Length :25mm

-Electric lode : None

(4) Pressure 500gf , 45deg

### 3. Integration Design Guide

- Avoid the design that Front-case overlap and press on the active area of the touch-panel.
- Give enough gap (over 0.5mm at compressed) between the front case and touch-panel to protect wrong operating.
- Use a buffer material(Gasket) between the touch-panel and Front-case to protect damage and wrong operating.
- Avoid the design that buffer material overlap and press on the inside of touch-panel viewing area.

## ◆ 9. INTERFACE PIN CONNECTIONS

NO.	Symbol	Function
1	VLED-	Backlight negative
2	VLED+	Backlight positive
3	GND	Ground
4	VDD	Power supply
5	R0	data bus(Red)
6	R1	
7	R2	
8	R3	
9	R4	
10	R5	
11	R6	
12	R7	
13	G0	data bus(Green)
14	G1	
15	G2	
16	G3	
17	G4	
18	G5	
19	G6	
20	G7	
21	B0	data bus(Blue)
22	B1	
23	B2	
24	B3	
25	B4	
26	B5	
27	B6	
28	B7	
29	GND	Ground
30	PCLK	Pixel clock singal
31	DISP	Display on/off control
32	HSYNC	Horizontal sync signal
33	VSYNC	Vertical sync signal
34	DE	Data enable
35	AVDD	NC
36	GND	Ground
37	XR	Touch panel interface
38	YD	
39	XL	
40	YU	

## ◆ 10. ELECTRO-OPTICAL CHARACTERISTICS

Driving condition: VDD=3.3V, I<sub>BL</sub>=32mA, Temperature =23°C±5°C , Humidity=60%±20%RH

Item	Light angle ( ° )	Temp ( °C )	Symbol	Specifications			Unit	Conditions	Note		
				Min.	Typ.	Max.					
Transmittance	0	25	-	-	6.1	-	%	(1)			
Contrast ratio	0	25	Cr	-	500	-	-	(2)			
Brightness	0	25	-	280	320	-	cd/m <sup>2</sup>	-			
Luminance uniformity (surface within panel)	0	25	Lu	70	80	-	%	(3)			
Cross talk	0	25	CTV	-	-	20	%	(4)			
Chromaticity	R x	0	25	Rx	0.5604	0.6104	0.6604	-	(Equipment :BM-7/CS-200)	-	
	R y			Ry	0.3014	0.3514	0.4014				
	G x			Gx	0.2793	0.3293	0.3793				
	G y			Gy	0.5242	0.5742	0.6242				
	B x			Bx	0.0932	0.1432	0.1932				
	B y			By	0.0332	0.0832	0.1332				
	W x			Wx	0.2381	0.2881	0.3381				
	W y			Wy	0.2521	0.3021	0.3521				
Color Reproduction Area(NTSC)		0	25	-	-	57	-	%	CIE1931(x,y)	(5)	
Response time	Tr	0	25	-	-	5	-	ms	Viewing normal angle $\theta_x = \theta_y = 0^0$	-	
	Tf			-	-	15	-				
Viewing angle	Hor.	0	25	-	-	60	-	deg	Center CR≥10	-	
				$\theta_{x+}$	-	-	60				-
	Ver.			$\theta_{y+}$	-	-	65				-
				$\theta_{y-}$	-	-	45				-

**Note:**

### (1). Transmittance

#### Introduction

Transmittance (diffuse transmission factor) is a measure for the LCD panel transparency. The Light Source for this measurement is the accompanying LCD-module backlight system (LEDs, Lightguide...)

**Measurement conditions:**

Measuring Equipment	BM-7/CS-200
Measurement Point Diameter	3mm
Measurement Point Location	Active Area Center Point
Light source	LCD module backlight
Reflectance Plate	Reflectance Standard(cal. plate)
Test pattern	All pixels white
Contrast setting	Maximum

**Measuring procedure:**

**Transmittance:**

The light source is located at the backside of the panel.

- 1、 Measure the light source
- 2、 Place the LCD panel in front of the light source. Measure the luminance on the LCD panel surface

**Definitions**

$$\tau = \frac{L_{V_{LCD-panel}}}{L_{V_{lightsource}}} * 100\%$$

- (2) Definition of Contrast Ratio (C/R): Ratio of gray max (Gmax) & gray min (Gmin) at the center point.

$$CR = \frac{G(Max)}{G(Min)}$$

Where

Gmax: Luminance with all pixels white

Gmin: Luminance with all pixels black

- (3). Surface luminance uniformity within panel

**Measurement conditions:**

Measuring Equipment	CS200 // BM-7
Measurement Point Diameter	3mm // 1mm
Measurement Point Location	Active Area
Light Source	Transmissive Mode: Internal (Backlight)
Test pattern	White

**Measuring procedure:**

Measure the luminance  $L_i$  with the points in figure 1.

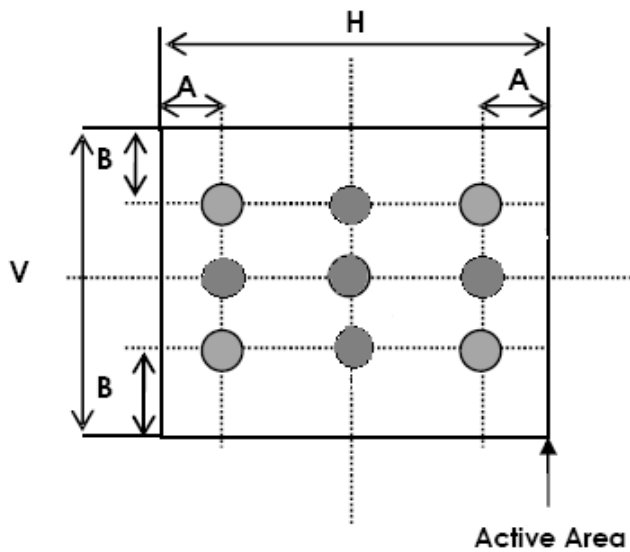

**Figure 1**

A: 5 mm    B: 5 mm  
H, V: Active Area

**Uniformity value ( $L_u$ ):**

$$L_u = \frac{\min(L_i)}{\max(L_i)} * 100\%$$

#### (4) . CROSS-TALK

##### Introduction :

Crosstalk is an effect where the contrast of a display pixel is influenced by the state of the related pixels. A measure for this effect is the Cross Talk Value (CTV)

##### Measurement conditions:

<b>Measuring Equipment</b>	<b>CS200 // BM-7</b>
<b>Measurement Point Diameter</b>	<b>3mm // 1mm</b>
<b>Measurement Point Location</b>	
<b>Light Source</b>	<b>Transmissive Mode: Internal (Backlight)</b>
<b>Contrast setting</b>	<b>Maximum</b>

##### •Test Pattern (valid for all greyscales):

**W:** The width of the rectangle in the following pictures;

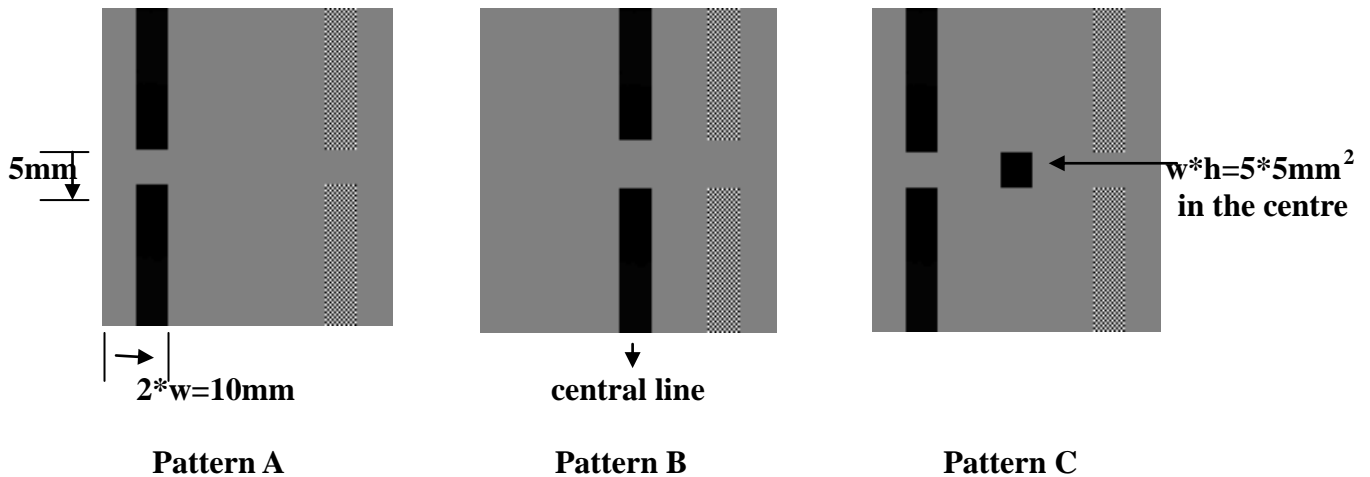

● **Definitions :**

**Cross Talk Value :**

$$CTV = |L_{vA} - L_{vB}| / L_{vA} * 100\%$$

**Where :**

**L<sub>vA</sub>:** Luminance measured with the centre test point of pattern A

**L<sub>vB</sub>:** Luminance measured with the centre test point of pattern B.

● **Measuring procedure :**

Adaptation of the display to the highest contrast ratio (CR = L<sub>vA</sub>/L<sub>vC</sub>) as defined by the test patterns and a test area of 14 x 14 dots.

Measurement of Luminance with test point A, B.

Determination of Crosstalk value (CTV)

(5). NTSC

**Measurement conditions:**

Measuring Equipment	LCD-5200
Measuring Point Diameter	3mm//1mm
Measuring point location	Active Area center point
Light source	Transmissive Mode: internal(Backlight)
Test pattern	All Pixels White Red.Green.Blue.White: Maximum colour saturation (maximum gradation level)
Contrast setting	Maximum

## Definitions

Panel color coordinates according the CIE colour system (CIE 1931). In general, It is always requested to measure the X, Y and Z values.

Here  $u'$ ,  $v'$  and  $L^*$  are according CIE 1931:

$$x' = \frac{4 \cdot X}{X + 15 \cdot Y + 3 \cdot Z}$$

$$y' = \frac{9 \cdot Y}{X + 15 \cdot Y + 3 \cdot Z}$$

$$L^* = 116 \cdot \left( \frac{Y}{Y_n} \right)^{1/3} - 16$$

Colour distance definition (maximum allowed colour distance to specified typical colour coordinate):

$$\Delta x' y' = \sqrt{\Delta x'^2 + \Delta y'^2}$$

Where:

$$\Delta x' = \text{Max} \left| x'_{typ} - x'_{max} \right|, \left| x'_{typ} - x'_{min} \right|$$

$$\Delta y' = \text{Max} \left| y'_{typ} - y'_{max} \right|, \left| y'_{typ} - y'_{min} \right|$$

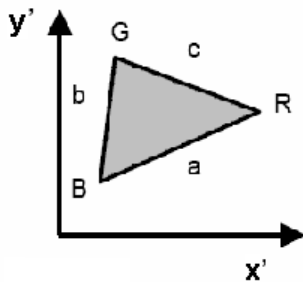

Color Gamut definition:

$$F = \sqrt{s \left( \frac{a}{s} - a \right) \left( \frac{b}{s} - b \right) \left( \frac{c}{s} - c \right)} * 1000$$

Where

$$s = \frac{a + b + c}{2}$$

$$a = \sqrt{x'_{blue} - x'_{red} \quad ^2 + y'_{blue} - y'_{red} \quad ^2}$$

$$b = \sqrt{x'_{blue} - x'_{green} \quad ^2 + y'_{blue} - y'_{green} \quad ^2}$$

$$c = \sqrt{x'_{red} - x'_{green} \quad ^2 + y'_{red} - y'_{green} \quad ^2}$$

Color Gamut Ratio (NTSC) related to NTSC':

NTSC: =F (display)/F (NTSC')

NTSC' primaries:

	$x'$	$y'$
<b>Red</b>	<b>0.67</b>	<b>0.33</b>
<b>Green</b>	<b>0.21</b>	<b>0.71</b>
<b>Blue</b>	<b>0.14</b>	<b>0.08</b>

F (NTSC') =74.42

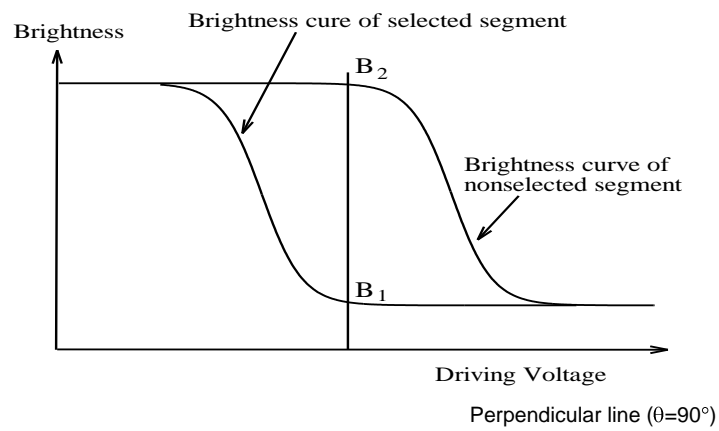
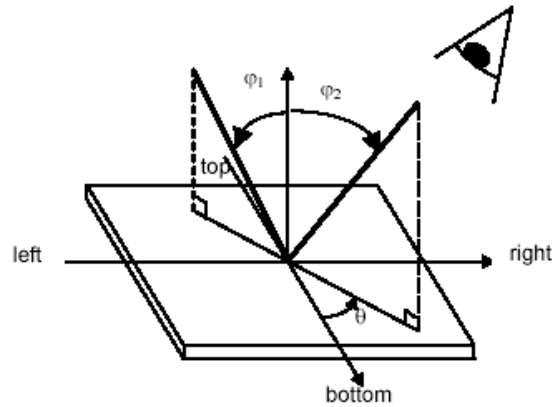
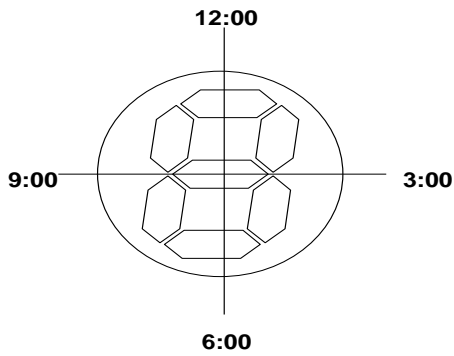



## ◆ 11. INSPECTION CRITERION

This specification is made to be used as the standard acceptance/rejection criteria for Color mobile phone LCM.

### 1 Sample plan

Sampling method shall be in accordance with MIL-STD-105D, inspection level II and based on:

Major defect: AQL 0.65

Minor defect: AQL 1.5

### 2. Inspection condition

Viewing distance for cosmetic inspection is about 30cm with bare eyes, and under an environment of 20~40W light intensity, all directions for inspecting the sample should be within 45° against perpendicular line.

### 3. Definition of inspection zone in LCD.

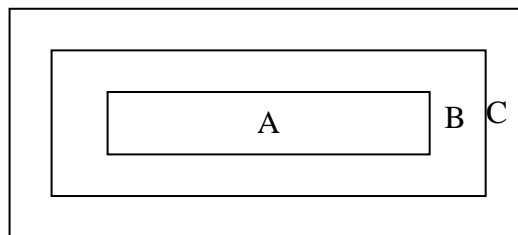

Zone A: character/Digit area

Zone B: viewing area except Zone A (ZoneA+ZoneB=minimum Viewing area)

Zone C: Outside viewing area (invisible area after assembly in customer's product)

Fig.1 Inspection zones in an LCD.

Note: As a general rule, visual defects in Zone C are permissible, when it is no trouble for quality and assembly of customer's product

## 4. Inspection standards

### 4.1 Major Defect

Item No	Items to be inspected	Inspection Standard	Classification of defects
4.1.1	All functional defects	1) No display 2) Display abnormally 3) Missing vertical , horizontal segment 4) Short circuit 5) Back-light no lighting, flickering and abnormal lighting.	Major
4.1.2	Missing	Missing component	
4.1.3	Outline dimension	Overall outline dimension beyond the drawing is not allowed.	

### 4.2 Cosmetic Defect

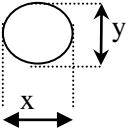
Item No	Items to be inspected	Inspection Standard	Classification of defects																							
4.2.1	Clear Spots	<p>For dark/white spot, size <math>\Phi</math> is defined</p>  <p>as <math>\Phi = \frac{(x+y)}{2}</math></p>	Minor																							
	Black and white Spot defect Pinhole, Foreign Particle, Dirt under polarizer	<p>1 .</p> <table border="1"> <thead> <tr> <th rowspan="2">Size(mm) \ Zone</th> <th colspan="3">Acceptable Qty</th> </tr> <tr> <th>A</th> <th>B</th> <th>C</th> </tr> </thead> <tbody> <tr> <td><math>\Phi \leq 0.1</math></td> <td colspan="3">Ignore</td> </tr> <tr> <td><math>0.10 &lt; \Phi \leq 0.2</math></td> <td colspan="3">3</td> </tr> <tr> <td><math>0.2 &lt; \Phi \leq 0.3</math></td> <td colspan="3">2</td> </tr> <tr> <td><math>\Phi &gt; 0.3</math></td> <td colspan="3">0</td> </tr> </tbody> </table>		Size(mm) \ Zone	Acceptable Qty			A	B	C	$\Phi \leq 0.1$	Ignore			$0.10 < \Phi \leq 0.2$	3			$0.2 < \Phi \leq 0.3$	2			$\Phi > 0.3$	0		
Size(mm) \ Zone	Acceptable Qty																									
	A	B	C																							
$\Phi \leq 0.1$	Ignore																									
$0.10 < \Phi \leq 0.2$	3																									
$0.2 < \Phi \leq 0.3$	2																									
$\Phi > 0.3$	0																									
	Dim Spots	<p>2.</p> <table border="1"> <thead> <tr> <th rowspan="2">2. Zone \ Size(mm)</th> <th colspan="3">Acceptable Qty</th> </tr> <tr> <th>A</th> <th>B</th> <th>C</th> </tr> </thead> <tbody> <tr> <td><math>\Phi \leq 0.2</math></td> <td colspan="3">Ignore</td> </tr> <tr> <td><math>0.20 &lt; \Phi \leq 0.40</math></td> <td colspan="3">2</td> </tr> <tr> <td><math>0.40 &lt; \Phi \leq 0.60</math></td> <td colspan="3">1</td> </tr> <tr> <td><math>0.60 &lt; \Phi</math></td> <td colspan="3">0</td> </tr> </tbody> </table>	2. Zone \ Size(mm)	Acceptable Qty			A	B	C	$\Phi \leq 0.2$	Ignore			$0.20 < \Phi \leq 0.40$	2			$0.40 < \Phi \leq 0.60$	1			$0.60 < \Phi$	0			Minor
2. Zone \ Size(mm)	Acceptable Qty																									
	A	B	C																							
$\Phi \leq 0.2$	Ignore																									
$0.20 < \Phi \leq 0.40$	2																									
$0.40 < \Phi \leq 0.60$	1																									
$0.60 < \Phi$	0																									

4.2. Cosmetic Defect

Item No	Items to be inspected	Inspection Standard	Classification of defects																																	
4.2.2	Line defect Black line, White line, Foreign material under polarizer,	<table border="1"> <thead> <tr> <th colspan="2">Size(mm)</th> <th colspan="3">Acceptable Qty</th> </tr> <tr> <th rowspan="2">L(Length)</th> <th rowspan="2">W(Width)</th> <th colspan="3">Zone</th> </tr> <tr> <th>A</th> <th>B</th> <th>C</th> </tr> </thead> <tbody> <tr> <td>Ignore</td> <td><math>W \leq 0.02</math></td> <td colspan="3">Ignore</td> </tr> <tr> <td><math>L \leq 3.0</math></td> <td><math>0.02 &lt; W \leq 0.03</math></td> <td colspan="3">2</td> </tr> <tr> <td><math>L \leq 2.0</math></td> <td><math>0.03 &lt; W \leq 0.05</math></td> <td colspan="3">1</td> </tr> <tr> <td></td> <td><math>0.05 &lt; W</math></td> <td colspan="3">Define as spot defect</td> </tr> </tbody> </table>	Size(mm)		Acceptable Qty			L(Length)	W(Width)	Zone			A	B	C	Ignore	$W \leq 0.02$	Ignore			$L \leq 3.0$	$0.02 < W \leq 0.03$	2			$L \leq 2.0$	$0.03 < W \leq 0.05$	1				$0.05 < W$	Define as spot defect			Minor
Size(mm)		Acceptable Qty																																		
L(Length)	W(Width)	Zone																																		
		A	B	C																																
Ignore	$W \leq 0.02$	Ignore																																		
$L \leq 3.0$	$0.02 < W \leq 0.03$	2																																		
$L \leq 2.0$	$0.03 < W \leq 0.05$	1																																		
	$0.05 < W$	Define as spot defect																																		
4.2.3	Polarizer scratch	<p>If the Polarizer scratch can be seen after mobile phone cover assembling or in the operating condition, judge by the line defect of 4.2.2.</p> <p>If the Polarizer scratch can be seen only in non-operating condition or some special angle, judge by the following.</p> <table border="1"> <thead> <tr> <th colspan="2">Size(mm)</th> <th colspan="3">Acceptable Qty</th> </tr> <tr> <th rowspan="2">L(Length)</th> <th rowspan="2">W(Width)</th> <th colspan="3">Zone</th> </tr> <tr> <th>A</th> <th>B</th> <th>C</th> </tr> </thead> <tbody> <tr> <td>Ignore</td> <td><math>W \leq 0.03</math></td> <td colspan="3">Ignore</td> </tr> <tr> <td><math>5.0 &lt; L \leq 10.0</math></td> <td><math>0.03 &lt; W \leq 0.05</math></td> <td colspan="3">2</td> </tr> <tr> <td><math>L \leq 5.0</math></td> <td><math>0.05 &lt; W \leq 0.08</math></td> <td colspan="3">1</td> </tr> <tr> <td></td> <td><math>0.08 &lt; W</math></td> <td colspan="3">0</td> </tr> </tbody> </table>	Size(mm)		Acceptable Qty			L(Length)	W(Width)	Zone			A	B	C	Ignore	$W \leq 0.03$	Ignore			$5.0 < L \leq 10.0$	$0.03 < W \leq 0.05$	2			$L \leq 5.0$	$0.05 < W \leq 0.08$	1				$0.08 < W$	0			Minor
Size(mm)		Acceptable Qty																																		
L(Length)	W(Width)	Zone																																		
		A	B	C																																
Ignore	$W \leq 0.03$	Ignore																																		
$5.0 < L \leq 10.0$	$0.03 < W \leq 0.05$	2																																		
$L \leq 5.0$	$0.05 < W \leq 0.08$	1																																		
	$0.08 < W$	0																																		
4.2.4	Polarize Air bubble	<p>Air bubbles between glass &amp; polarizer</p> <table border="1"> <thead> <tr> <th rowspan="2">2. Zone Size(mm)</th> <th colspan="3">Acceptable Qty</th> </tr> <tr> <th>A</th> <th>B</th> <th>C</th> </tr> </thead> <tbody> <tr> <td><math>\Phi \leq 0.2</math></td> <td colspan="3">Ignore</td> </tr> <tr> <td><math>0.20 &lt; \Phi \leq 0.30</math></td> <td colspan="3">2</td> </tr> <tr> <td><math>0.30 &lt; \Phi \leq 0.50</math></td> <td colspan="3">1</td> </tr> <tr> <td><math>0.50 &lt; \Phi</math></td> <td colspan="3">0</td> </tr> </tbody> </table>	2. Zone Size(mm)	Acceptable Qty			A	B	C	$\Phi \leq 0.2$	Ignore			$0.20 < \Phi \leq 0.30$	2			$0.30 < \Phi \leq 0.50$	1			$0.50 < \Phi$	0			Minor										
2. Zone Size(mm)	Acceptable Qty																																			
	A	B	C																																	
$\Phi \leq 0.2$	Ignore																																			
$0.20 < \Phi \leq 0.30$	2																																			
$0.30 < \Phi \leq 0.50$	1																																			
$0.50 < \Phi$	0																																			

4.3. Cosmetic Defect

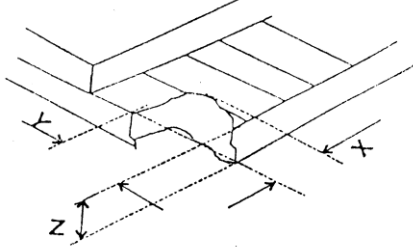
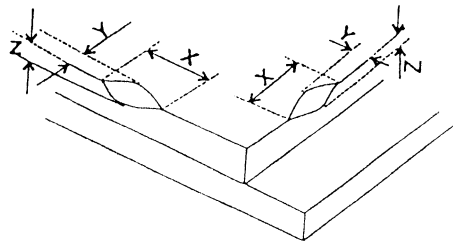
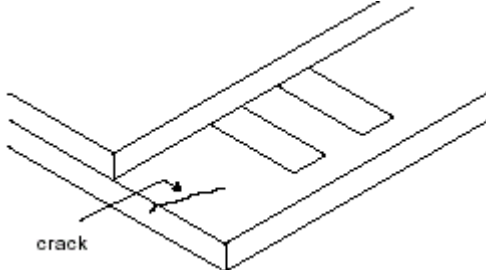
Item No	Items to be inspected	Inspection Standard	Classification of defects						
4.3.5	Glass defect	<p>(i) Chips on corner</p>  <table border="1" data-bbox="480 660 1115 770"> <thead> <tr> <th>X</th> <th>Y</th> <th>Z</th> </tr> </thead> <tbody> <tr> <td>≤ 2.0</td> <td>≤ S</td> <td>Disregard</td> </tr> </tbody> </table> <p>Notes: S=contact pad length Chips on the corner of terminal shall not be allowed to extend into the ITO pad or expose perimeter seal.</p>	X	Y	Z	≤ 2.0	≤ S	Disregard	Minor
		X	Y	Z					
		≤ 2.0	≤ S	Disregard					
<p>(ii) Usual surface cracks</p>  <table border="1" data-bbox="459 1214 1136 1323"> <thead> <tr> <th>X</th> <th>Y</th> <th>Z</th> </tr> </thead> <tbody> <tr> <td>≤ 3.0</td> <td>&lt; Inner border line of the seal</td> <td>Disregard</td> </tr> </tbody> </table>	X	Y	Z	≤ 3.0	< Inner border line of the seal	Disregard	Minor		
X	Y	Z							
≤ 3.0	< Inner border line of the seal	Disregard							
<p>(iii) Crack</p> <p>Cracks tend to break are not allowed.</p> 	Major								
4.3.6	Parts alignment	<p>1) Not allow IC and FPC/heat-seal lead width is more than 50% beyond lead pattern. 2) Not allow chip or solder component is off center more than 50% of the pad outline.</p>	Minor						
4.3.7	SMT	According to the <Acceptability of electronic assemblies> IPC-A-610C class 2 standard. Component missing or function defect are Major defect, the others are Minor defect.							

## ◆ 12. PRECAUTIONS FOR USING LCD MODULES

### Handling Precautions

(1) The display panel is made of glass and polarizer. As glass is fragile. It tends to become or chipped during handling especially on the edges. Please avoid dropping or jarring. Do not subject it to a mechanical shock by dropping it or impact.

(2) If the display panel is damaged and the liquid crystal substance leaks out, be sure not to get any in your mouth. If the substance contacts your skin or clothes, wash it off using soap and water.

(3) Do not apply excessive force to the display surface or the adjoining areas since this may cause the color tone to vary. Do not touch the display with bare hands. This will stain the display area and degraded insulation between terminals (some cosmetics are determined to the polarizer).

(4) The polarizer covering the display surface of the LCD module is soft and easily scratched. Handle this polarizer carefully. Do not touch, push or rub the exposed polarizer's with anything harder than an HB pencil lead (glass, tweezers, etc.). Do not put or attach anything on the display area to avoid leaving marks on. Condensation on the surface and contact with terminals due to cold will damage, stain or dirty the polarizer. After products are tested at low temperature they must be warmed up in a container before coming in contact with room temperature air.

(5) If the display surface becomes contaminated, breathe on the surface and gently wipe it with a soft dry cloth. If it is heavily contaminated, moisten cloth with one of the following solvents

- Isopropyl alcohol
- Ethyl alcohol

Do not scrub hard to avoid damaging the display surface.

(6) Solvents other than those above-mentioned may damage the polarizer. Especially, do not use the following.

- Water
- Ketone
- Aromatic solvents

Wipe off saliva or water drops immediately, contact with water over a long period of time may cause deformation or color fading. Avoid contacting oil and fats.

(7) Exercise care to minimize corrosion of the electrode. Corrosion of the electrodes is accelerated by water droplets, moisture condensation or a current flow in a high-humidity environment.

(8) Install the LCD Module by using the mounting holes. When mounting the LCD module make sure it is free of twisting, warping and distortion. In particular, do not forcibly pull or bend the I/O cable or the backlight cable.

(9) Do not attempt to disassemble or process the LCD module.

(10) NC terminal should be open. Do not connect anything.

(11) If the logic circuit power is off, do not apply the input signals.

(12) Electro-Static Discharge Control , Since this module uses a CMOS LSI, the same careful attention should be paid to electrostatic discharge as for an ordinary CMOS IC. To prevent destruction of the elements by static electricity, be careful to maintain an optimum work environment.

- Before remove LCM from its packing case or incorporating it into a set, be sure the module and your body have the same electric potential. Be sure to ground the body when handling the LCD modules.

- Tools required for assembling, such as soldering irons, must be properly grounded. make certain the AC power source for the soldering iron does not leak. When using an electric screwdriver to attach LCM, the screwdriver should be of ground potentiality to minimize as much as possible any transmission of electromagnetic waves produced sparks coming from the commutator of the motor.

- To reduce the amount of static electricity generated, do not conduct assembling and other work under dry conditions. To reduce the generation of static electricity be careful that the air in the work is not too dried. A relative humidity of 50%-60% is recommended. As far as possible make the electric potential of your work clothes and that of the work bench the ground potential

- The LCD module is coated with a film to protect the display surface. Exercise care when peeling off this protective film since static electricity may be generated

( 13 ) Since LCM has been assembled and adjusted with a high degree of precision, avoid applying excessive shocks to the module or making any alterations or modifications to it.

- Do not alter, modify or change the shape of the tab on the metal frame.
  - Do not make extra holes on the printed circuit board, modify its shape or change the positions of components to be attached.
  - Do not damage or modify the pattern writing on the printed circuit board.
  - Absolutely do not modify the zebra rubber strip (conductive rubber) or heat seal connector.
  - Except for soldering the interface, do not make any alterations or modifications with a soldering iron.
  - Do not drop, bend or twist LCM.

### **Storage Precautions**

When storing the LCD modules, the following precaution is necessary.

- (1) Store them in a sealed polyethylene bag. If properly sealed, there is no need for the desiccant.
- (2) Store them in a dark place. Do not expose to sunlight or fluorescent light, keep the temperature between 0°C and 35°C.
- (3) The polarizer surface should not come in contact with any other objects. (We advise you to store them in the container in which they were shipped).

### **Others**

Liquid crystals solidify under low temperature (below the storage temperature range) leading to defective orientation or the generation of air bubbles (black or white). Air bubbles may also be generated if the module is subject to a low temperature.

If the LCD modules have been operating for a long time showing the same display patterns, the display patterns may remain on the screen as ghost images and a slight contrast irregularity may also appear. A normal operating status can be regained by suspending use for some time. It should be noted that this phenomenon does not adversely affect performance reliability.

To minimize the performance degradation of the LCD modules resulting from destruction caused by static electricity etc., exercise care to avoid holding the following sections when handling the modules.

- Exposed area of the printed circuit board.
- Terminal electrode sections.

### **Limited Warranty**

Unless agreed between Shelly Associates Inc. and customer, Shelly will replace or repair any of its LCD modules which are found to be functionally defective when inspected in accordance with Shelly Associates Inc. acceptance standards (copies available upon request) for a period of one year from date of shipments. Cosmetic/visual defects must be returned to Shelly within 90 days of shipment. Confirmation of such date shall be based on freight documents. The warranty liability of Shelly Associates Inc. is limited to repair and/or replacement on the terms set forth above. Shelly Associates Inc. will not be responsible for any subsequent or consequential events.